

AL AND HYDRAULICS, INC.

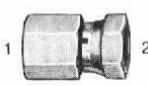

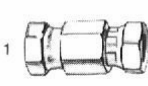

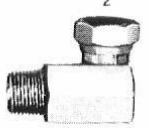

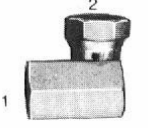
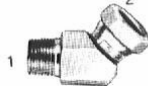
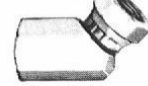
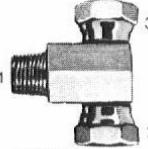
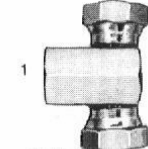
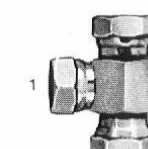
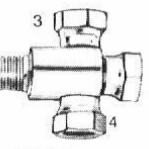





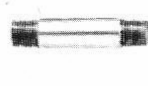



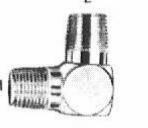

"FLUID POWER FOR PROGRESS"

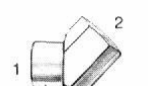
Main Office: 4412 South 87th Street - Omaha, NE 68127 Phone: (402) 339-3873 or (800) 642-8829
Branch Office: 2507 West 5th Street - Sioux Falls, SD 57104 Phone: (605) 330-0535 or (866) 280-3599

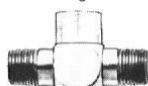
PIPE SWIVEL ADAPTERS

 <p>1404-Str. (1) Male Pipe (2) Fem. Pipe Swivel</p>	 <p>1405-Str. (1) Fem. Pipe (2) Fem. Pipe Swivel</p>	 <p>1406-Str. (1) (2) Fem. Pipe Swivel.</p>	 <p>1501-90° (1) Male Pipe (2) Fem. Pipe Swivel</p>	 <p>1502-90 (1) Fem. Pipe (2) Fem. Pipe Swivel</p>	 <p>1503-45 (1) Male Pipe (2) Fem. Pipe Swivel</p>	 <p>1504-45° (1) Fem. Pipe (2) Fem. Pipe Swivel</p>
 <p>1601-Tee (1) Male Pipe (2) (3) Fem. Pipe Swivel</p>	 <p>1602-Tee (1) Fem. Pipe (2) (3) Fem. Pipe Swivel</p>	 <p>1603-Tee (1) (2) (3) Fem. Pipe Swivel</p>	 <p>1604-Cross (1) Male Pipe (2) (3) (4) Fem. Pipe Swivel</p>	<p>See back page for dash # guide and sample part #.</p>		

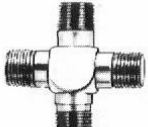
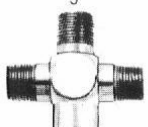
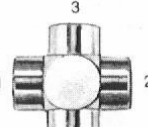
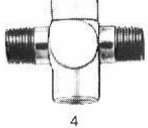
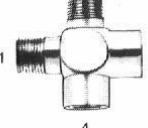
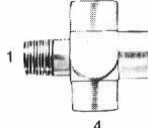

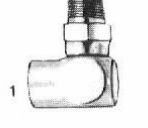











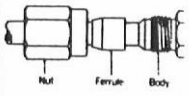





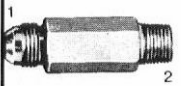





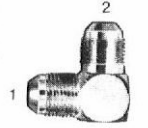

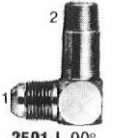

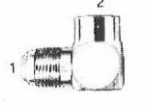

PIPE FITTINGS

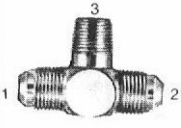
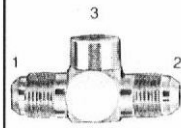
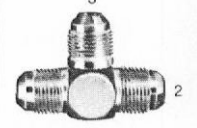
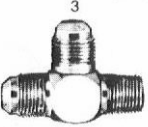
<p>(140138)</p>  <p>5000-Str. (1) (2) Fem. Pipe</p>	<p>(140137)</p>  <p>5404-Str. (1) (2) Male Pipe</p>	 <p>5404-N-Str. Nipple (1) (2) Male Pipe</p>	<p>(140139)</p>  <p>5405-Str. Reducer (1) Male Pipe (2) Fem. Pipe</p>	<p>(140140)</p>  <p>5406-Bushing (1) Male Pipe (2) Fem. Pipe</p>	<p>(130109E)</p>  <p>5406-P-Plug (1) Male Pipe</p>	 <p>5500-90 (1) (2) Male Pipe</p>
 <p>5501-45° (1) (2) Male Pipe</p>	<p>(140239)</p>  <p>5502-90° (1) Male Pipe (2) Fem. Pipe</p>	<p>(140339)</p>  <p>5503-45° (1) Male Pipe (2) Fem. Pipe</p>	<p>(140238)</p>  <p>5504-90° (1) (2) Fem. Pipe</p>	<p>(140338)</p>  <p>5505-45° (1) (2) Fem. Pipe</p>	 <p>5600-Tee (1) (2) (3) Male Pipe</p>	 <p>5601-Tee (1) (2) Male Pipe (3) Fem. Pipe</p>
<p>(140424)</p>  <p>5602-Tee (1) Male Pipe (2) (3) Fem. Pipe</p>	 <p>5603-Tee (1) (3) Male Pipe (2) Fem. Pipe</p>	<p>(140425)</p>  <p>5604-Tee (1) (2) Fem. Pipe (3) Male Pipe</p>	<p>(140438)</p>  <p>5605-Tee (1) (2) (3) Fem. Pipe</p>	 <p>5650-Cross (1) (2) (3) (4) Male Pipe</p>	 <p>5651-Cross (1) (2) (3) Male Pipe (4) Fem. Pipe</p>	 <p>5652-Cross (1) (2) (3) (4) Fem. Pipe</p>
 <p>5653-Cross (1) (2) Male Pipe (3) (4) Fem. Pipe</p>	 <p>5654-Cross (1) (3) Male Pipe (2) (4) Fem. Pipe</p>	 <p>5655-Cross (1) Male Pipe (2) (3) (4) Fem. Pipe</p>	 <p>5500S-90° (1) Male Pipe (2) Male Pipe Swivel</p>	 <p>5502S-90° (1) Fem. Pipe (2) Male Pipe Swivel</p>		

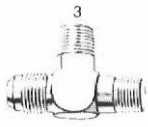
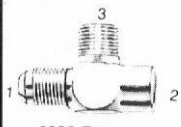
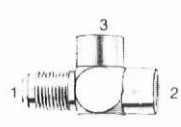
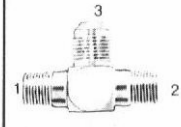

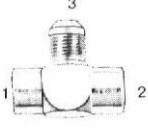
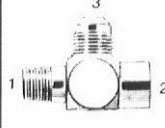
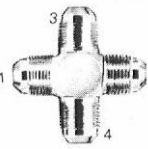
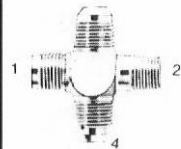
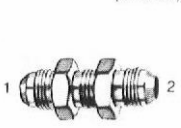
A^{AND}L HYDRAULICS, INC.

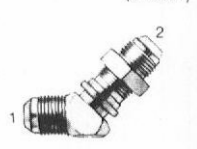
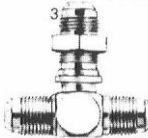
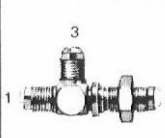
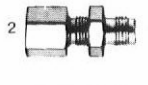
"FLUID POWER FOR PROGRESS"

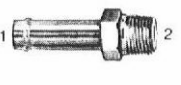
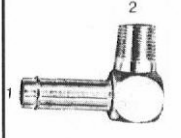
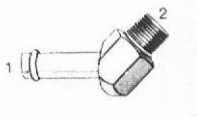



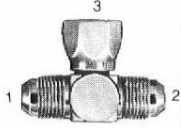
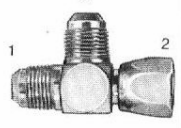
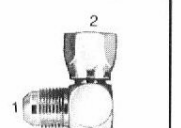
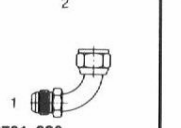

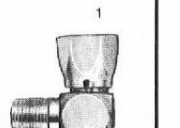
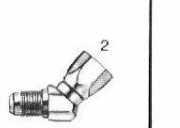
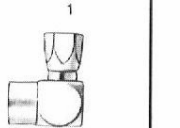
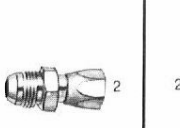
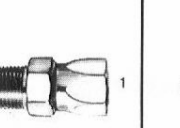
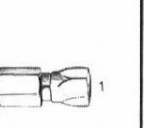





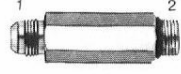



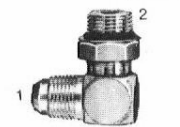

37° TUBE FITTINGS: JIC Fittings

 <p>403-Str. (1) Bore (2) Male Tube</p>	 <p>304-Standard Nut</p>	 <p>(070112) 304-C Cap Nut</p>	 <p>(070118) 306-Bulkhead Lock Nut</p>	 <p>418 & 419 "No Flare" Nut and Sleeve</p>	 <p>(070110) 318-Tube Nut</p>	 <p>(070115) 319-Tube Sleeve</p>
 <p>(070101) 2403-Str. (1) (2) Male Tube Union</p>	 <p>(070119) 2403-LH-Str. (1) (2) Male Tube Union Large Hex</p>	 <p>(070102) 2404-Str. (1) Male Tube (2) Male Pipe</p>	 <p>(070102L) 2404-L-Str. (1) Male Tube (2) Male Pipe — Long</p>	 <p>2404-LL-Str. (1) Male Tube (2) Male Pipe — Ex. Long</p>	 <p>2404-LLL-Str. (1) Male Tube (2) Male Pipe — Ex-Ex-Long</p>	 <p>(070103) 2405-Str. (1) Male Tube (2) Fem. Pipe</p>
 <p>(070123) 2406-Str. Reducer (1) 37° Fem. (2) Male Tube</p>	 <p>(070109) 2408-(1) Male Tube Plug</p>	 <p>(070201) 2500-90° (1) (2) Male Tube</p>	 <p>(070202) 2501-90° (1) Male Tube (2) Male Pipe</p>	 <p>(071502) 2501-L-90° (1) Male Tube (2) Male Pipe — Long</p>	 <p>(071602) 2501-LL-90° (1) Male Tube (2) Male Pipe — Ex. Long</p>	 <p>(070203) 2501-LLL-90° (1) Male Tube (2) Male Pipe — Ex-Ex-Long</p>
 <p>2502-90° (1) Male Tube (2) Fem. Pipe</p>	 <p>(070302) 2503-45° (1) Male Tube (2) Male Pipe</p>	 <p>2501S-90° (1) Male Tube (2) Male Pipe Swivel</p>	 <p>2505-45° (1) Male Tube (2) Fem. Pipe</p>	 <p>(070425) 2601-Tee (1) (2) Male Tube (3) Male Pipe</p>	 <p>(070427) 2602-Tee (1) (2) Male Tube (3) Fem. Pipe</p>	 <p>(070401) 2603-Tee (1) (2) (3) Male Tube</p>
 <p>(070424) 2605-Tee (1) (3) Male Tube (2) Male Pipe</p>	 <p>(070426) 2606-Tee (1) (3) Male Tube (2) Fem. Pipe</p>	 <p>2607-Tee (1) Male Tube (2) (3) Male Pipe</p>	 <p>(070434) 2608-Tee (1) Male Tube (2) Fem. Pipe (3) Male Pipe</p>	 <p>2609-Tee (1) Male Tube (2) (3) Fem. Pipe</p>	 <p>2610-Tee (1) (2) Male Pipe (3) Male Tube</p>	 <p>(070435) 2611-Tee (1) Male Tube (2) Male Pipe (3) Fem. Pipe</p>
 <p>2612-Tee (1) (2) Fem. Pipe (3) Male Tube</p>	 <p>2613-Tee (1) Male Pipe (2) Fem. Pipe (3) Male Tube</p>	 <p>(070501) 2650-Cross (1) (2) (3) (4) Male Tube</p>	 <p>2651-Cross (1) (3) (4) Male Tube (2) Male Pipe</p>	 <p>(070601) 2700-LN-Str. (1) Male Tube (2) Bulkhead</p>	 <p>(070701) 2701-LN-90° (1) Male Tube (2) Bulkhead</p>	 <p>(070801) 2702-LN-45° (1) Male Tube (2) Bulkhead</p>
 <p>(070959) 2703-LN-Tee (1) (2) Male Tube (3) Bulkhead</p>	 <p>(070958) 2704-LN-Tee (1) (3) Male Tube (2) Bulkhead</p>	 <p>2705-LN-Str. (1) Bulkhead (2) Fem. Pipe</p>	 <p>2706-LN-Str. (1) Bulkhead (2) Male Pipe</p>	 <p>4404-Str. (1) Beaded (2) Male Pipe</p>	 <p>4501-90° (1) Beaded (2) Male Pipe</p>	 <p>4503-45° (1) Beaded (2) Male Pipe</p>

FEMALE 37° SWIVEL TUBE FITTINGS AND ADAPTERS

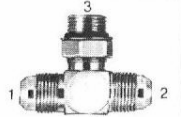
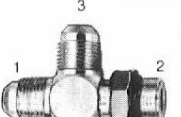
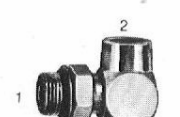
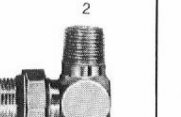
	(070433)  6600-Tee (1) (2) Male Tube (3) 37° Fem. Swivel.	(070432)  6602-Tee (1) (3) Male Tube (2) 37° Fem. Swivel.	(070221)  6500-90° (1) Male Tube (2) 37° Fem. Swivel.	 6701-90° (1) Male Tube (2) 37° Fem. Swivel	 6701-L-90° (1) Male Tube (2) 37° Fem. Swivel Ex-Long
 6501-90° (1) 37° Fem. Swivel (2) Male Pipe	 6502-45° (1) Male Tube (2) 37° Fem. Swivel.	 6503-90° (1) 37° Fem. Swivel (2) Fem. Pipe	 6504-Str. (1) Male Tube (2) 37° Fem. Swivel.	 6505-Str. (1) 37° Fem. Swivel (2) Male Pipe	 6506-Str. (1) 37° Fem. Swivel (2) Fem. Pipe

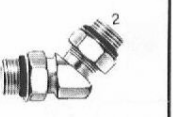
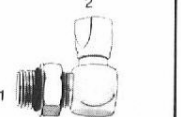
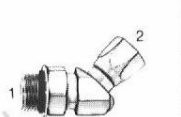
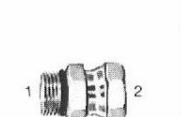
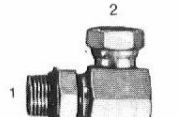
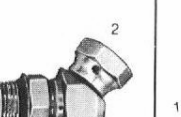
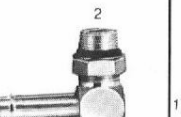
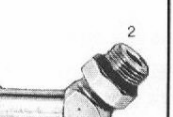
“O” RING TUBE FITTINGS AND PIPE ADAPTERS

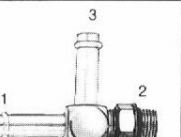
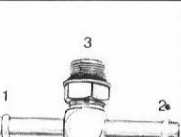
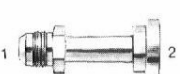
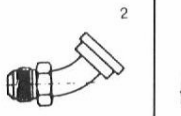
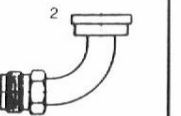
(070120)  6400-0 Str. (1) Male Tube (2) Male "O" Ring	(070122)  6400-L-0 Str. (1) Male Tube (2) Male "O" Ring Long	 6400-LL-0 Str. (1) Male Tube (2) Male "O" Ring Ex-Long	 6400-LLL-0 Str. (1) Male Tube (2) Male "O" Ring Ex-Ex-Long	 6401-0 Str. (1) Male "O" Ring (2) Male Pipe	 6402-0 Str. (1) 37° Fem. Swivel (2) Male "O" Ring	 6404-Str. (1) Fem. "O" Ring (2) Male Pipe
 6405-0 Str. (1) Male "O" Ring (2) Fem. Pipe	 6408-0 (1) Male "O" Ring Plug	 6410-0 Str. (1) Male "O" Ring (2) Fem. "O" Ring	(070220)  6801-NWO 90° (1) Male Tube (2) Adj. "O" Ring	 6801-L-NWO 90° (1) Male Tube (2) Adj. "O" Ring Long	 6801-LL-NWO 90° (1) Male Tube (2) Adj. "O" Ring Ex-Long	 6801-LLL-NWO 90° (1) Male Tube (2) Adj. "O" Ring Ex-Ex-Long
(070320)  6802-NWO 45° (1) Male Tube (2) Adj. "O" Ring	(070429)  6803-NWO Tee (1) (2) Male Tube (3) Adj. "O" Ring	(070428)  6804-NWO Tee (1) (3) Male Tube (2) Adj. "O" Ring	 6805-NWO 90° (1) Adj. "O" Ring (2) Fem. Pipe	 6806-NWO 90° (1) Adj. "O" Ring (2) Male Pipe	 6807-NWO 90° (1) (2) Adj. "O" Ring	 6808-NWO 45° (1) (2) Adj. "O" Ring
 6809-NWO 90° (1) Adj. "O" Ring (2) 37° Fem. Swivel.	 6810-NWO 45° (1) Adj. "O" Ring (2) 37° Fem. Swivel.	 6900-0 Str. (1) Male "O" Ring (2) Fem. Pipe Swivel	 6901-NWO 90° (1) Adj. "O" Ring (2) Fem. Pipe Swivel	 6902-NWO 45° (1) Adj. "O" Ring (2) Fem. Pipe Swivel	 4601-NWO 90° (1) Beaded (2) Adj. "O" Ring	 4603-NWO 45° (1) Beaded (2) Adj. "O" Ring
 4604-0 Str. (1) Beaded (2) Male "O" Ring	 4605-NWO Tee (1) (3) Beaded (2) Adj. "O" Ring	 4606-NWO Tee (1) (3) Beaded (2) Adj. "O" Ring	 6840-Str. (1) Male Tube (2) "O" Ring Flange	 6845-45° (1) (2) Beaded (2) "O" Ring Flange	 6890-90° (1) Male Tube (2) "O" Ring Flange	6842-Str. 6847-45° 6892-90° Code 62 FLANGE ADAPTERS 6000#

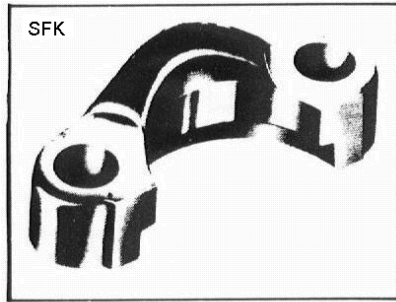

3000# SPLIT FLANGE HALF

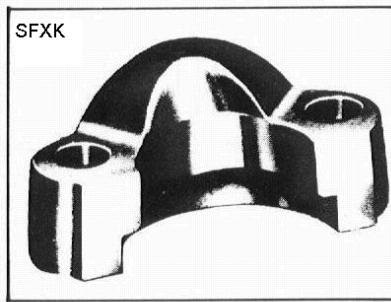

6000# SPLIT FLANGE HALF

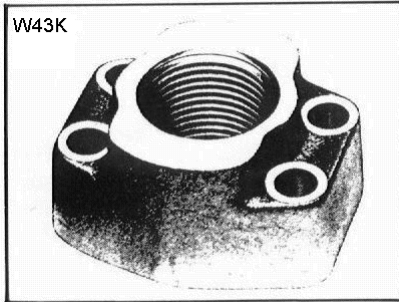

FEMALE PIPE FLANGE PAD

JIC/O-ring* Fittings				Pipe Fittings		
Thread Size	Dash Number	Thread OD	Decimal equivalent	Thread Size	Dash Number	NPTF Pipe Thread
1/8	2	5/16 - 24	.3125	1/8	2	1/8 -27
3/16	3	3/8 - 24	.375	1/4	4	1/4 -18
1/4	4	7/16 - 20	.4375	3/8	6	3/8 -18
5/16	5	1/2 - 20	.500	1/2	8	1/2 -14
3/8	6	9/16 - 18	.5625	3/4	12	3/4 -16
1/2	8	3/4 - 16	.750	1	16	1 -11-1/2
5/8	10	7/8 - 14	.875	1-1/4	20	1-1/4 -11-1/2
3/4	12	1-1/16 - 12	1.0625	1-1/2	24	1-1/2 -11-1/2
7/8	14	1-3/16 - 12	1.1875	2	32	2 -11-1/2
1	16	1-5/16 - 12	1.3125	Dash Numbers are derived from the number of sixteenths of an inch involved		
1-1/4	20	1-5/8 - 12	1.625			
1-1/2	24	1-7/8 - 12	1.875	*SAE O-ring fittings; not the same as flat-face oring fittings!		
2	32	2-1/2 - 12	2.500			

Sample:
 Part Number: **6400-8-12**
6400 indicates an adapter fitting, male JIC to a male oring
8 indicates the size of the male JIC: **8 = 1/2"**
12 indicates the size of the male oring: **12 = 3/4"**



Main Office: 4412 South 87th Street – Omaha, NE 68127

Phone: (402) 339-3873 or (800)642-8829

Branch Office: 2507 West 5th Street—Sioux Falls, SD 57104

Phone: (605) 330-0535 or (866) 280-3599

Email: sales@a-hydraulics.com **Web:** http://www.a-hydraulics.com